

CTB-1123 Refrigerator Car		
Description	Color	Quantity
Brick 2 x 4	Black	1
Magnet Cylindrical	Black	2
Plate 1 x 2	Black	4
Plate 1 x 4	Black	2
Plate 1 x 6	Black	12
Plate 1 x 8	Black	1
Plate 1 x 8 with Door Rail	Black	2
Plate 2 x 4	Black	2
Plate 2 x 6	Black	2
Plate 4 x 4	Black	1
Slope Brick 45 2 x 1 Inverted	Black	4
Train Bogie Plate	Black	2
Train Buffer Beam	Black	2
Train Coupling New	Black	2
Train Wheels 2	Black	4
Door 1 x 4 x 6	Blue	2
Plate 1 x 2	Light-Gray	2
Plate 1 x 2 with Ladder	Light-Gray	2
Plate 1 x 4	Light-Gray	2
Plate 2 x 2	Light-Gray	2
Plate 2 x 4	Light-Gray	4
Plate 2 x 8	Light-Gray	4
Plate 4 x 6	Light-Gray	4
Plate 4 x 10	Light-Gray	1
Technic Plate 2 x 8 with Holes	Light-Gray	2
Brick 1 x 1	White	2
Brick 1 x 2 Log	White	12
Brick 1 x 2 with Handle	White	2
Panel 2 x 5 x 6 Log Wall	White	7
Plate 1 x 1	White	2
Plate 1 x 8	White	1
Slope Brick 45 2 x 1	White	4
Slope Brick 45 2 x 6 x 2/3	White	6
Total		104

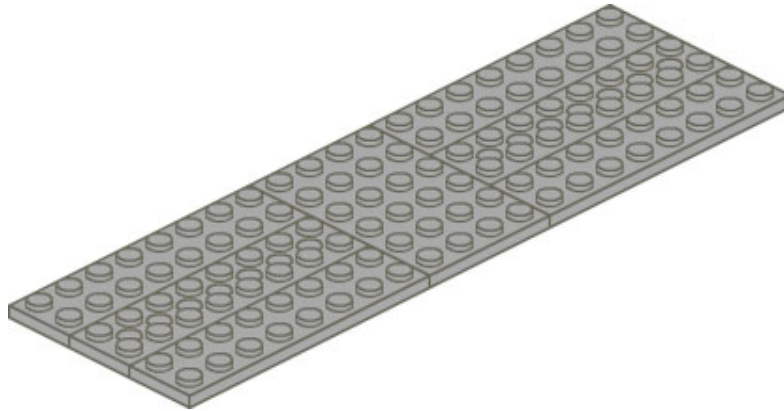

1



Page 2
CTB-1123 - Refrigerator Car

© 2002 Mike Walsh — All rights reserved.
Duplication, reproduction, or re-distribution expressly prohibited.

18

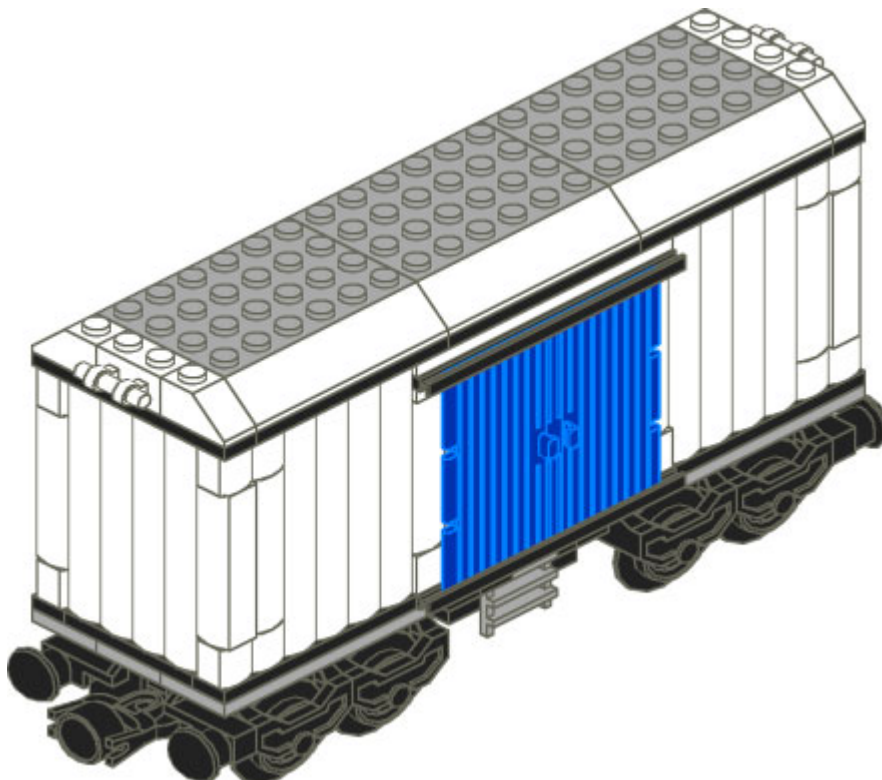

Page 19
CTB-1123 - Refrigerator Car

© 2002 Mike Walsh — All rights reserved.
Duplication, reproduction, or re-distribution expressly prohibited.

17

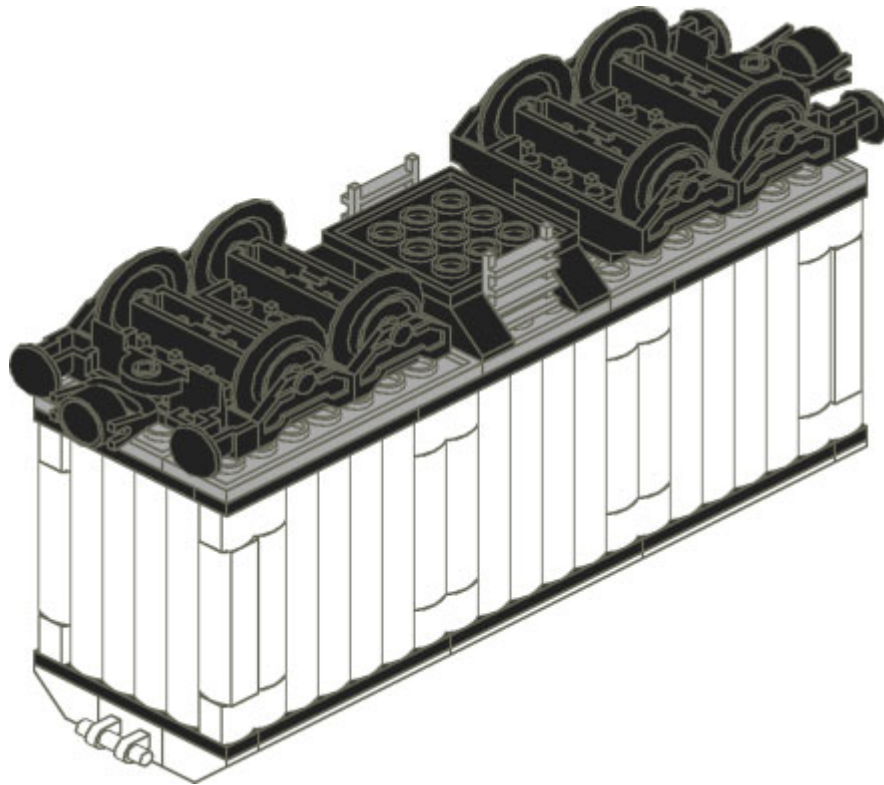

Page 18
CTB-1123 - Refrigerator Car

© 2002 Mike Walsh — All rights reserved.
Duplication, reproduction, or re-distribution expressly prohibited.

2

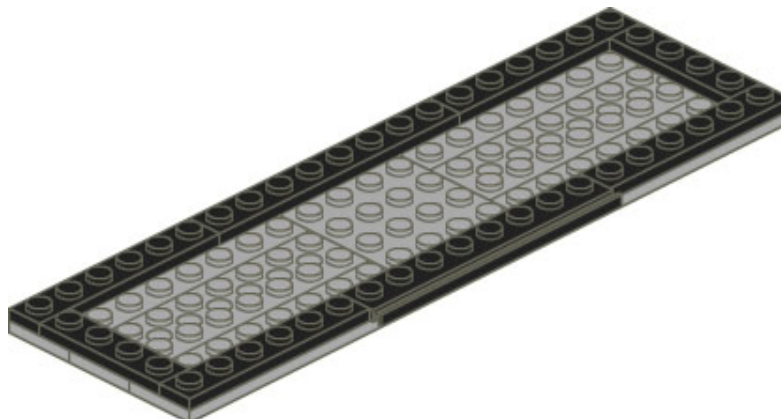

Page 3
CTB-1123 - Refrigerator Car

© 2002 Mike Walsh — All rights reserved.
Duplication, reproduction, or re-distribution expressly prohibited.

3

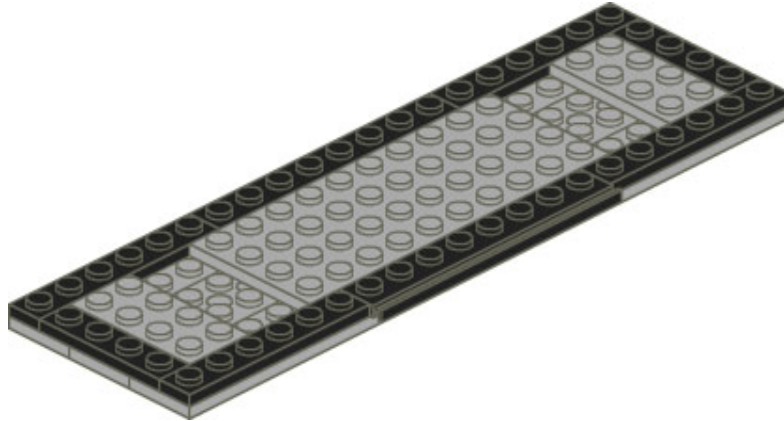

Page 4
CTB-1123 - Refrigerator Car

© 2002 Mike Walsh — All rights reserved.
Duplication, reproduction, or re-distribution expressly prohibited.

16

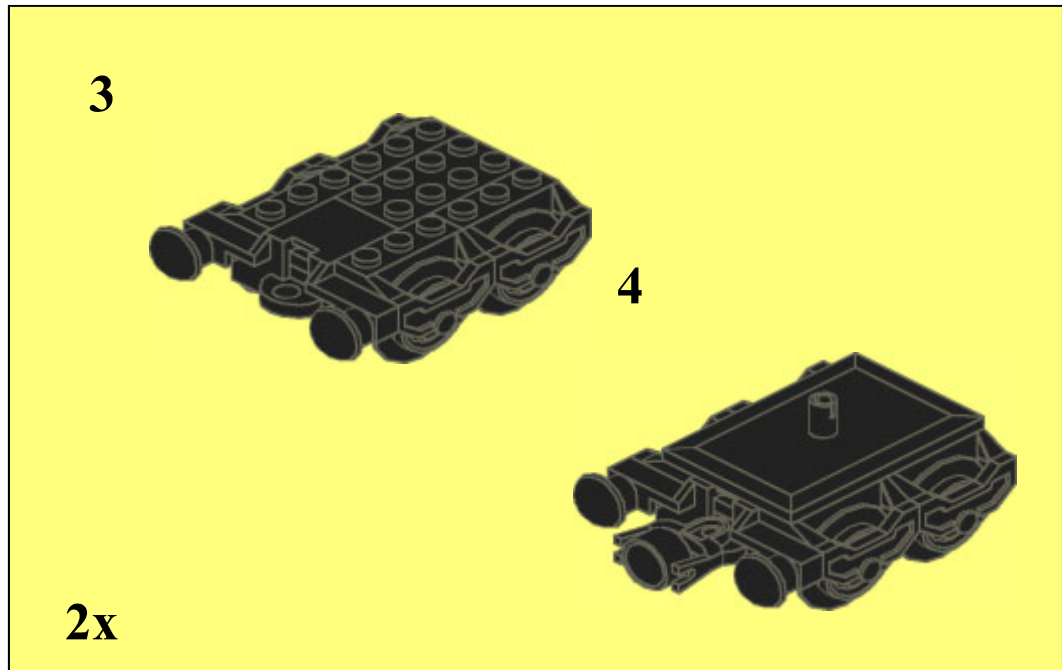

Page 17
CTB-1123 - Refrigerator Car

© 2002 Mike Walsh — All rights reserved.
Duplication, reproduction, or re-distribution expressly prohibited.

15

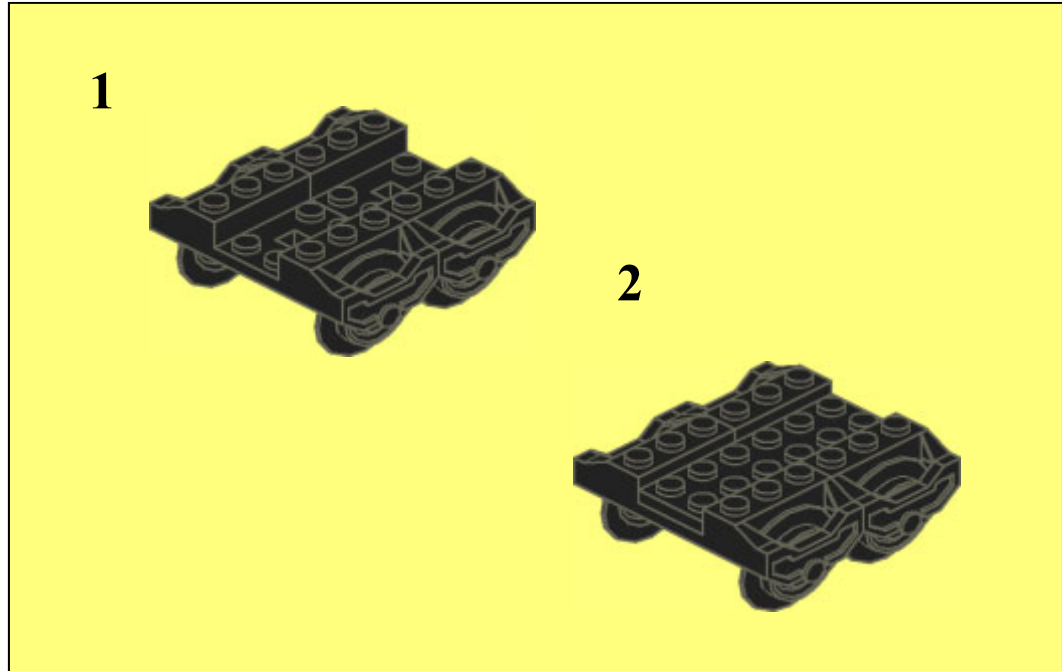

Page 16
CTB-1123 - Refrigerator Car

© 2002 Mike Walsh — All rights reserved.
Duplication, reproduction, or re-distribution expressly prohibited.

4

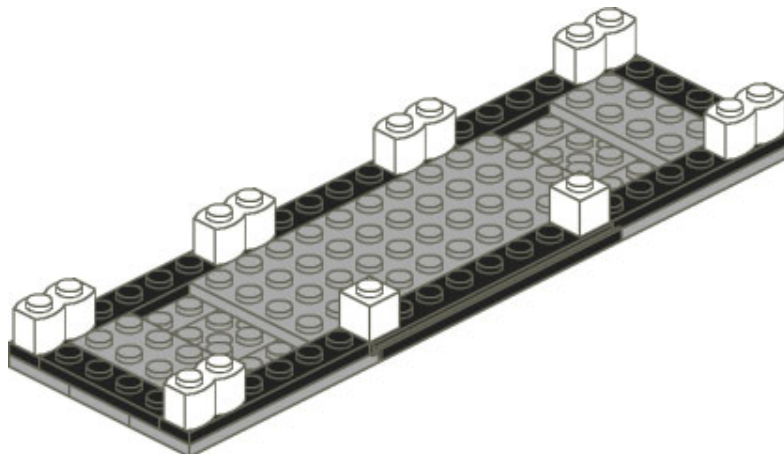

Page 5
CTB-1123 - Refrigerator Car

© 2002 Mike Walsh — All rights reserved.
Duplication, reproduction, or re-distribution expressly prohibited.

5

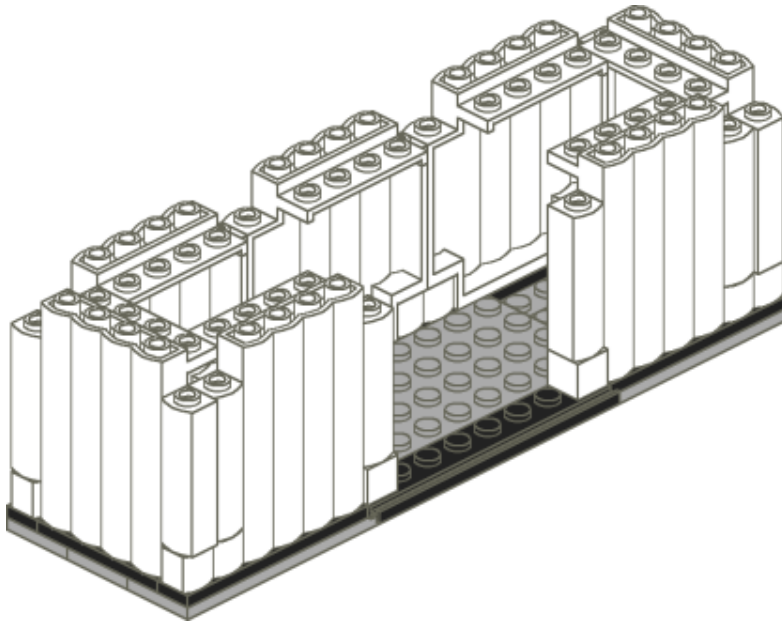

Page 6
CTB-1123 - Refrigerator Car

© 2002 Mike Walsh — All rights reserved.
Duplication, reproduction, or re-distribution expressly prohibited.

14

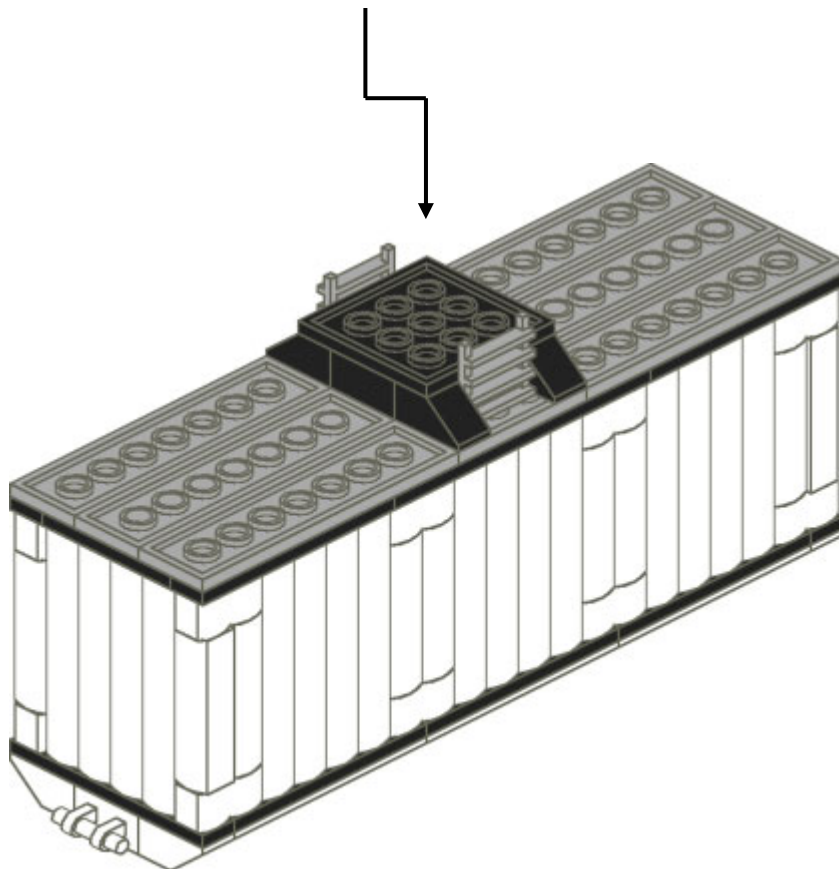

Page 15
CTB-1123 - Refrigerator Car

© 2002 Mike Walsh — All rights reserved.
Duplication, reproduction, or re-distribution expressly prohibited.

13

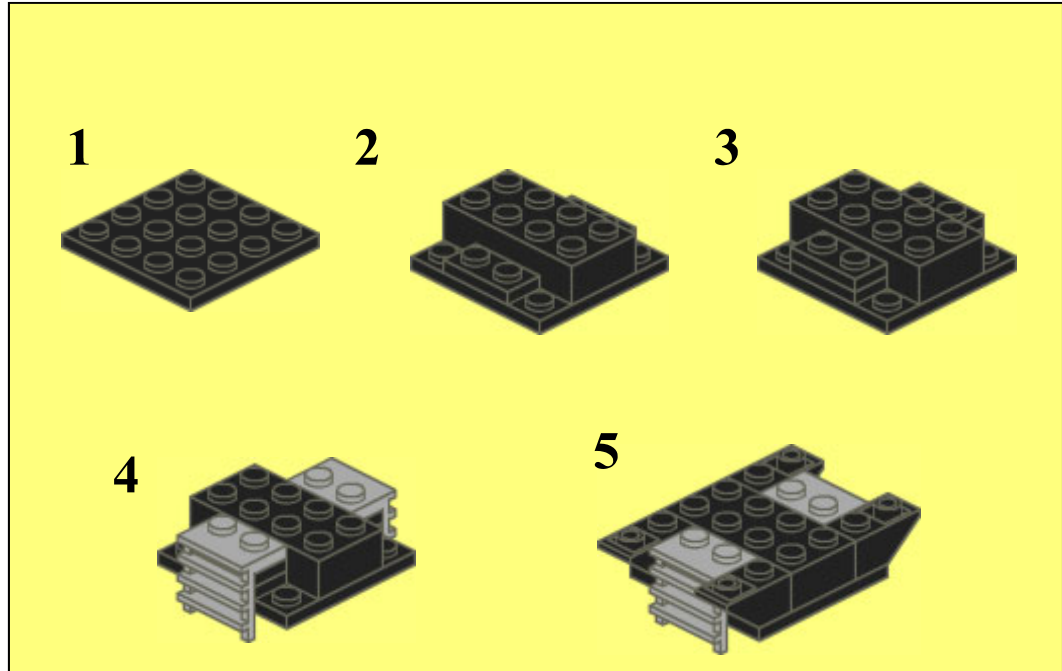

Page 14
CTB-1123 - Refrigerator Car

© 2002 Mike Walsh — All rights reserved.
Duplication, reproduction, or re-distribution expressly prohibited.

6

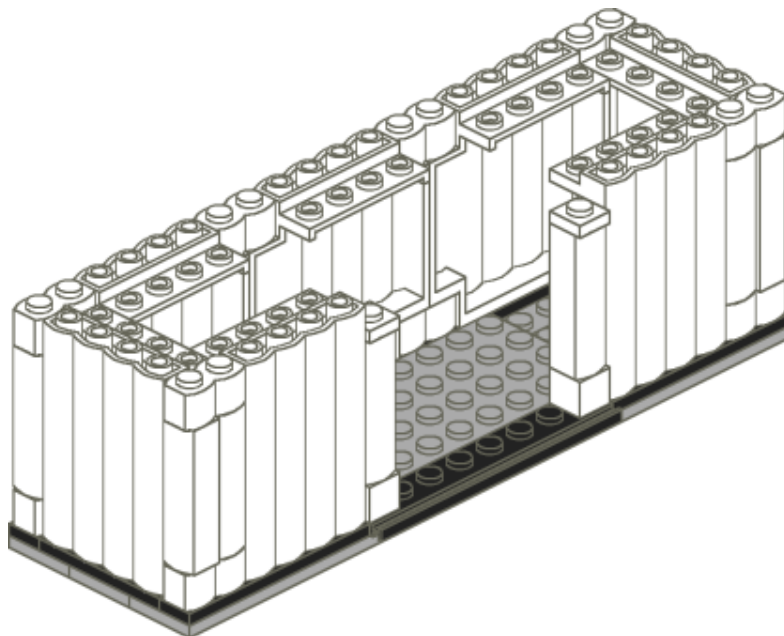

Page 7
CTB-1123 - Refrigerator Car

© 2002 Mike Walsh — All rights reserved.
Duplication, reproduction, or re-distribution expressly prohibited.

7

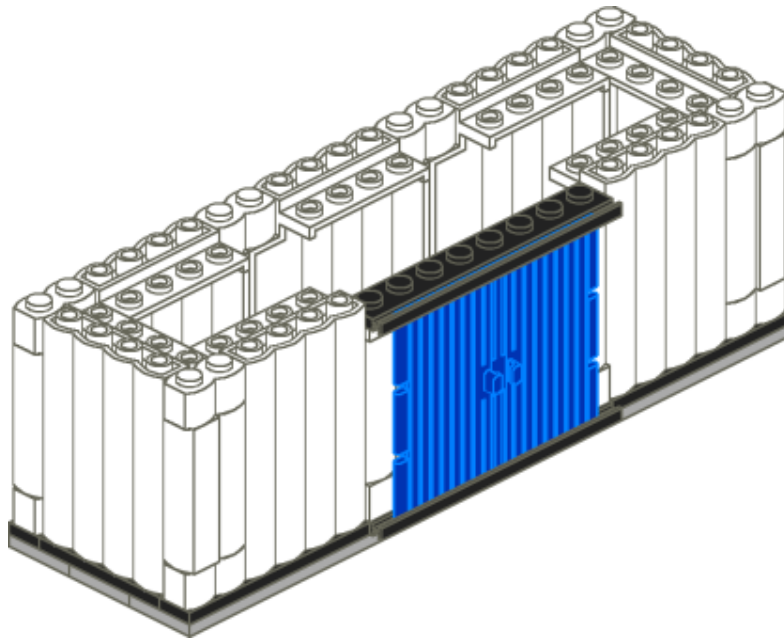

Page 8
CTB-1123 - Refrigerator Car

© 2002 Mike Walsh — All rights reserved.
Duplication, reproduction, or re-distribution expressly prohibited.

12

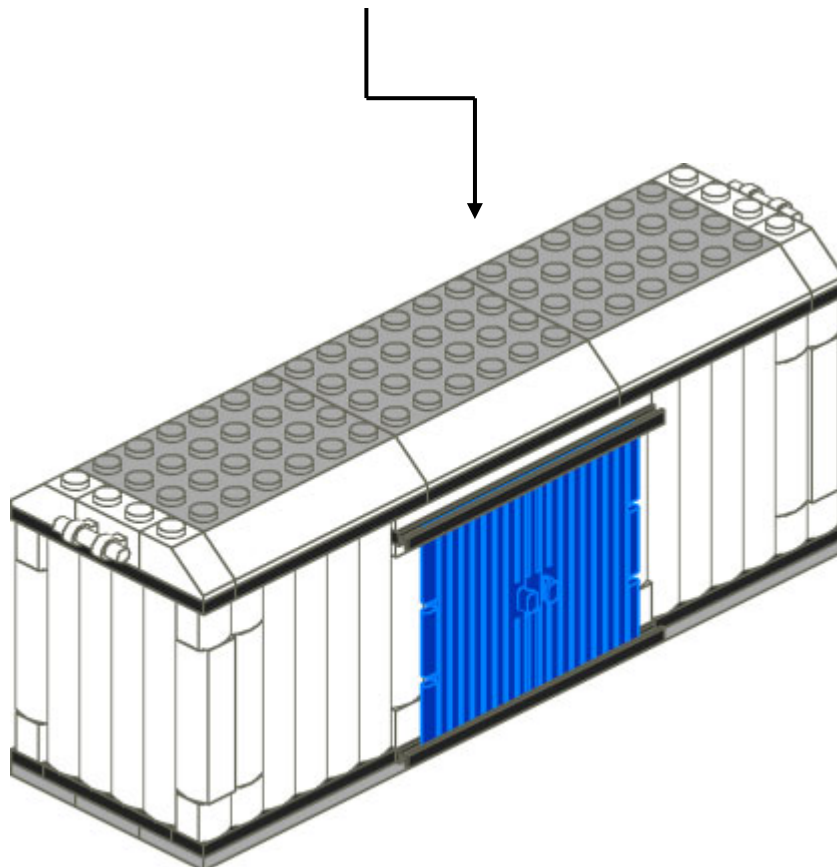

Page 13
CTB-1123 - Refrigerator Car

© 2002 Mike Walsh — All rights reserved.
Duplication, reproduction, or re-distribution expressly prohibited.

11

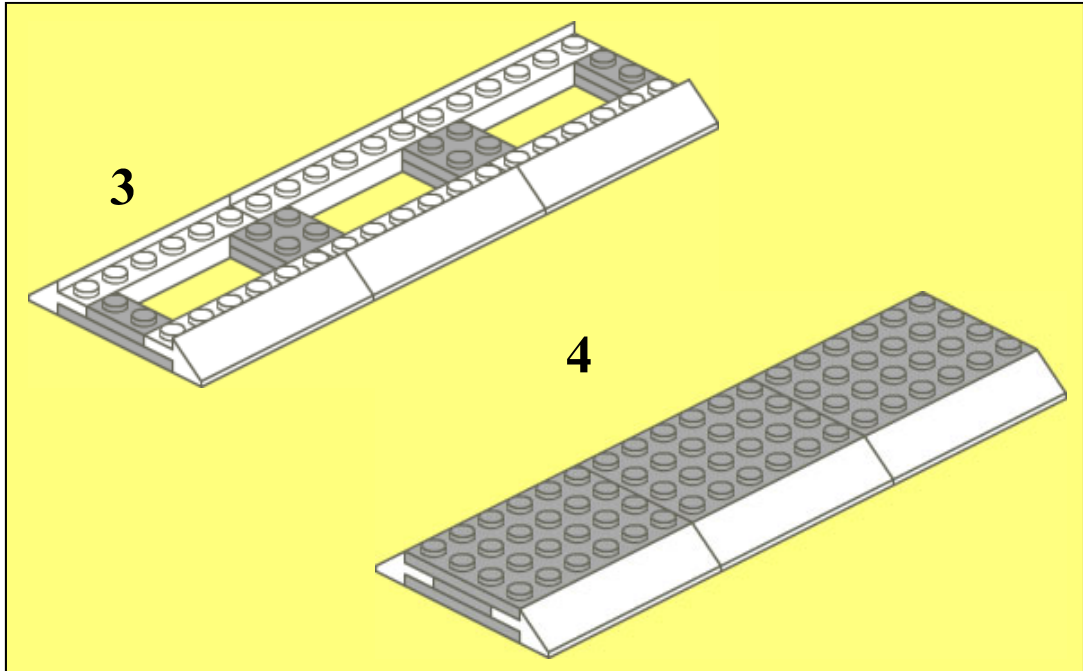

Page 12
CTB-1123 - Refrigerator Car

© 2002 Mike Walsh — All rights reserved.
Duplication, reproduction, or re-distribution expressly prohibited.

8

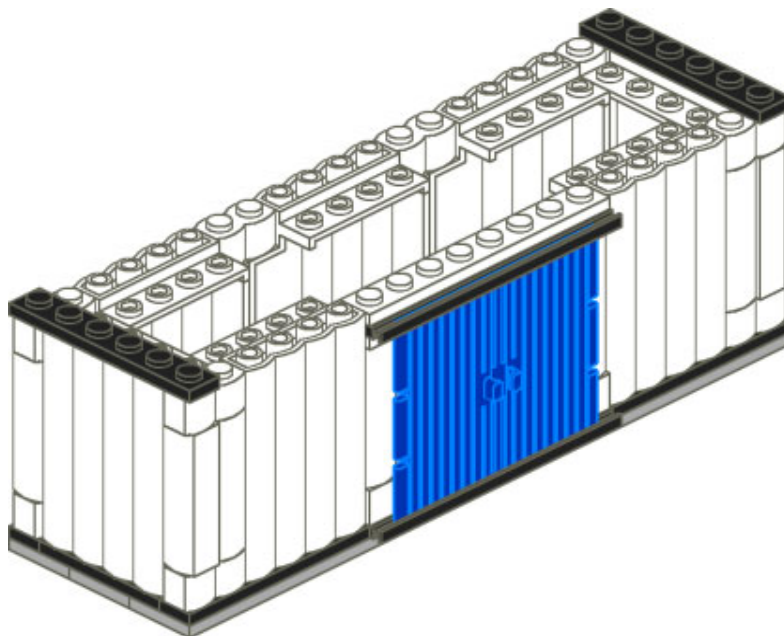

Page 9
CTB-1123 - Refrigerator Car

© 2002 Mike Walsh — All rights reserved.
Duplication, reproduction, or re-distribution expressly prohibited.

9

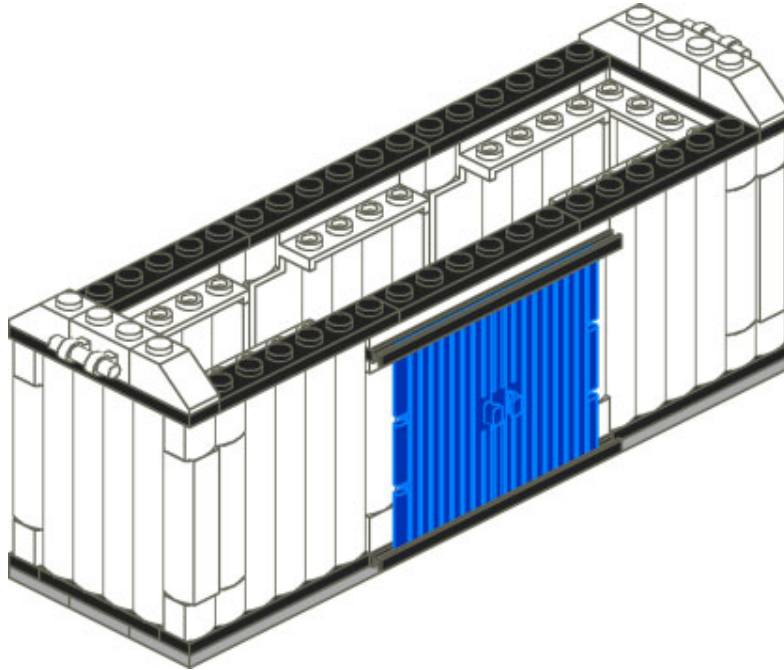

Page 10
CTB-1123 - Refrigerator Car

© 2002 Mike Walsh — All rights reserved.
Duplication, reproduction, or re-distribution expressly prohibited.

10

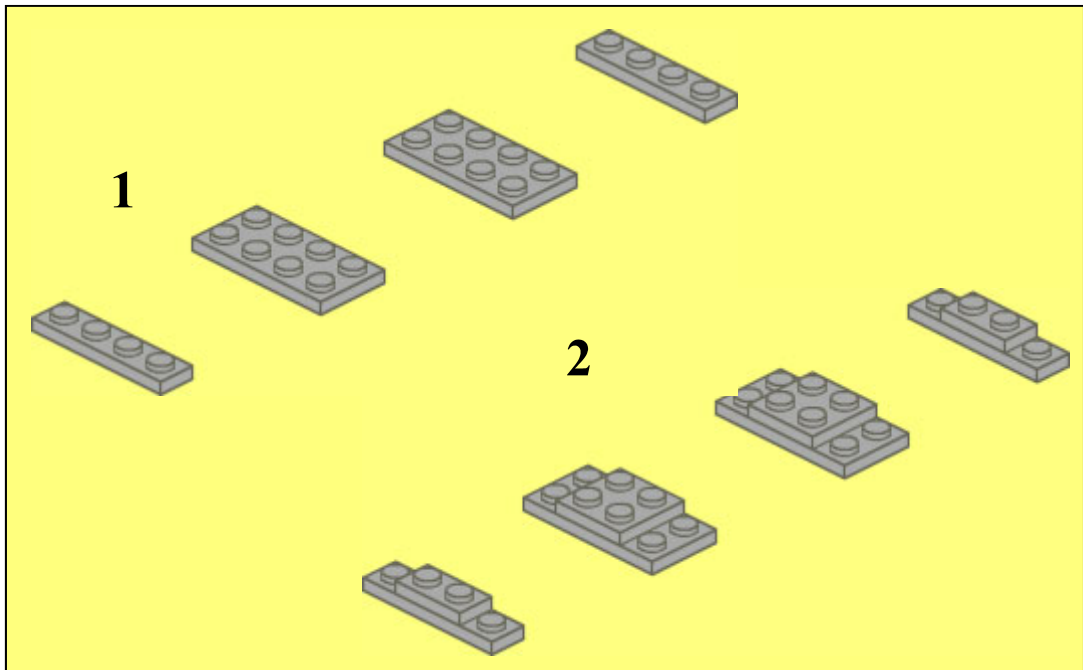

Page 11
CTB-1123 - Refrigerator Car

© 2002 Mike Walsh — All rights reserved.
Duplication, reproduction, or re-distribution expressly prohibited.